

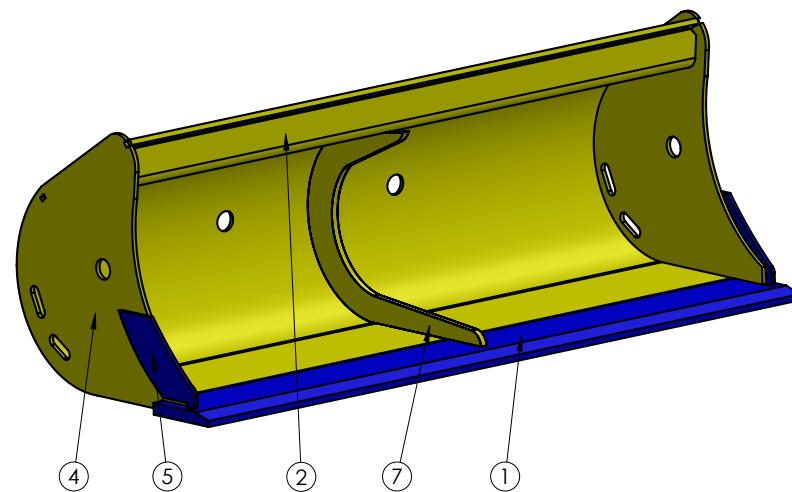

Lp	Grubość	Wsad
1	0	Lemiesz 16x110 HB500
2	5	BLA-S355
3	5	BLA-S355
4	6	BLA-S355
5	6	BLA-HB400
6	8	BLA-S355
7	10	BLA-S355

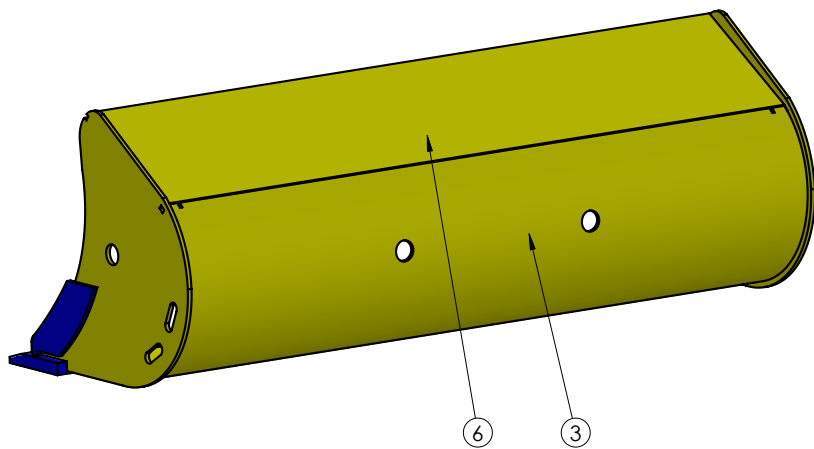

 ul. Komunalna 4 37-400 Pysznica www.keltec.pl biuro@keltec.pl	Nazwa :SKARPOWA 2-3T LE			
			Konstruował: RB	Skala 1:20
	Waga:	Materiał:	Data: 12.01.2022	Arkusz 1/1