

## ŁYŻKA SKARPOWA-LE 6-9T

Numer katalogowy Catalog number	Szerokość A [mm] Width A [mm]	Waga [kg] Weight [kg]	Poj. zalewowa [m <sup>3</sup> ] Capacity [m <sup>3</sup> ]	Poj. zasypowa [m <sup>3</sup> ] Capacity SAE [m <sup>3</sup> ]
01-0609-1200-LE	1234	139	0,16	0,22
01-0609-1300-LE	1334	149	0,18	0,25
01-0609-1400-LE	1434	159	0,19	0,27
01-0609-1500-LE	1534	169	0,20	0,28
01-0609-1600-LE	1634	178	0,22	0,31
01-0609-1700-LE	1734	188	0,23	0,32
01-0609-1800-LE	1834	202	0,24	0,34
01-0609-2000-LE	2034	218	0,27	0,38

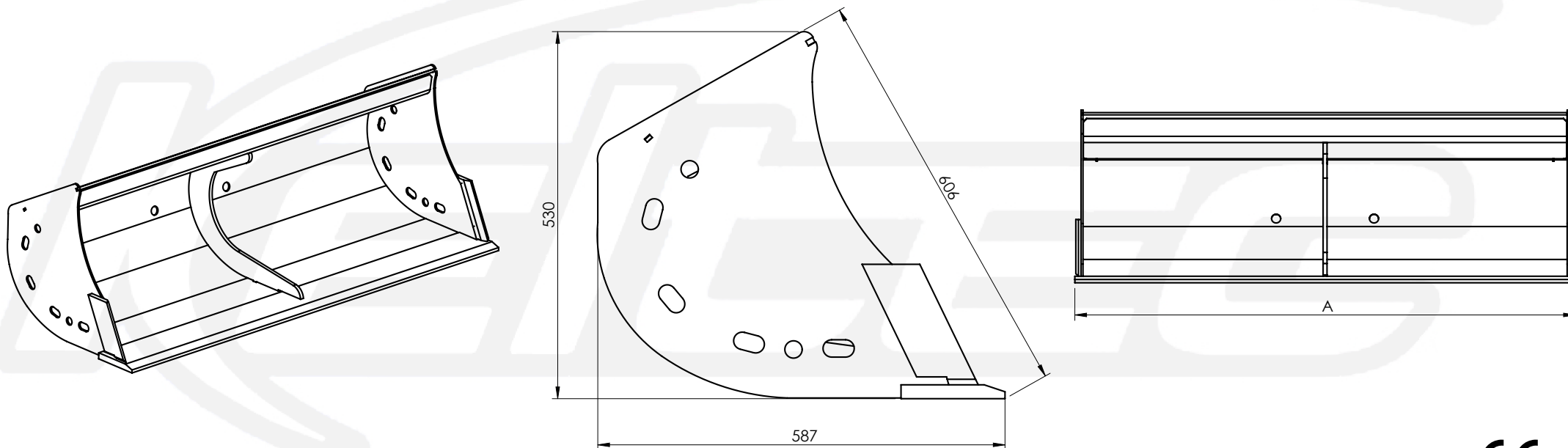

Keltec-PL Sp. z o.o.



37-403 Pysznica  
ul. Komunalna 4  
woj. podkarpackie



[www.keltec.pl](http://www.keltec.pl)  
[www.facebook.com/KeltecPL](https://www.facebook.com/KeltecPL)